

# LM34910 Evaluation Board

National Semiconductor  
Application Note 1349  
Dennis Morgan  
November 2004



## Introduction

The LM34910EVAL evaluation board provides the design engineer with a fully functional buck regulator, employing the constant on-time (COT) operating principle. This evaluation board provides a 5V output from an input range of 8V - 36V. The circuit provides load currents >1A, with the current limit set at  $\approx 1.3A$ .

The board's specification are:

- Input Voltage: 8V to 36V
- Output Voltage: 5V,  $\pm 3\%$
- Maximum Continuous Output current: 1.0A
- Current Limit: 1.3A
- Measured Efficiency: 92% ( $V_{IN} = 8V$ ,  $I_{OUT} = 400\text{ mA}$ )
- Switching Frequency:  $\approx 850\text{ kHz}$
- Size: 0.75 in. x 1.5 in. x 0.47 in

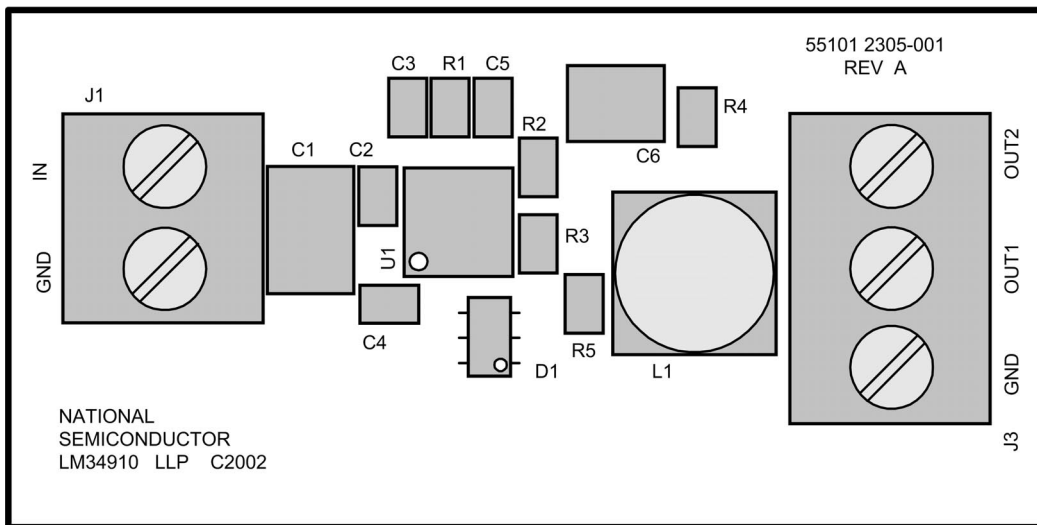

FIGURE 1. Evaluation Board - Top Side

## Theory of Operation

Refer to the board's schematic in *Figure 2*, which contains a simplified block diagram of the LM34910. When the circuit is in regulation, the buck switch is on each cycle for a time determined by R1 and  $V_{IN}$ . The on-time in this evaluation board will range from  $\approx 775\text{ ns}$  at  $V_{IN} = 8V$ , to  $\approx 200\text{ ns}$  at  $V_{IN} = 36V$ . At the end of the on-time, the feedback voltage at FB is above 2.5V, and the Minimum Off-Timer ensures the buck switch is off for at least 280 ns. In normal operation, the off-time is longer. During the off-time, the output capacitor (C6) discharges, and when the output voltage falls so that the voltage at FB is below 2.5V, the comparator output switches to initiate a new on-time. As required by the datasheet, this circuit provides a minimum of 25 mVp-p ripple at the FB pin. Refer to the LM34910 data sheet for a more detailed block diagram, and a complete description of the various functional blocks.

## Board Layout and Probing

The pictorial in *Figure 1* shows the placement of the circuit components. The following should be kept in mind when the board is powered:

- 1) When operating at high input voltage and high load current, forced air flow **IS NECESSARY**.
- 2) The LM34910, and the diode D1 will be hot to the touch when operating at high input voltage and high load current.
- 3) Use **CAUTION** when probing the circuit due to the compact layout.
- 4) At maximum load current (1A), the wire size and length used to connect the load becomes important. Ensure there is not a significant drop in the wires.

## Board Connection/Start-up

The input connections are made to the J1 connector. The load is normally connected to the OUT1 and GND terminals of the J3 connector. Ensure the wires are adequately sized for the intended load current. Before start-up a voltmeter should be connected to the input terminals, and to the output terminals. The load current should be monitored with an ammeter or a current probe. It is recommended that the input voltage be increased gradually to 8V, at which time the output voltage will be 5V. If that indicates correctly, then proceed with evaluating the circuit.

## Low Ripple Output

The ripple voltage at OUT1 will range from  $\approx 60$  mVp-p (at  $V_{IN} = 8V$ ) to  $\approx 160$  mVp-p (at  $V_{IN} = 36V$ ). If a low ripple output is desired, connect the load to OUT2. The ripple at this output varies from  $\approx 8$  mVp-p to  $\approx 26$  mVp-p over the input voltage range. However, the load regulation is not as good at OUT2 as it is at OUT1 due to the presence of R4.

## Increased Current Limit

The evaluation board current limit activates at a load current of  $\approx 1.3A$ . If it is desired to increase the current limit for a particular application, R5 must be added to the board. Refer to the data sheet to determine the appropriate value for this resistor

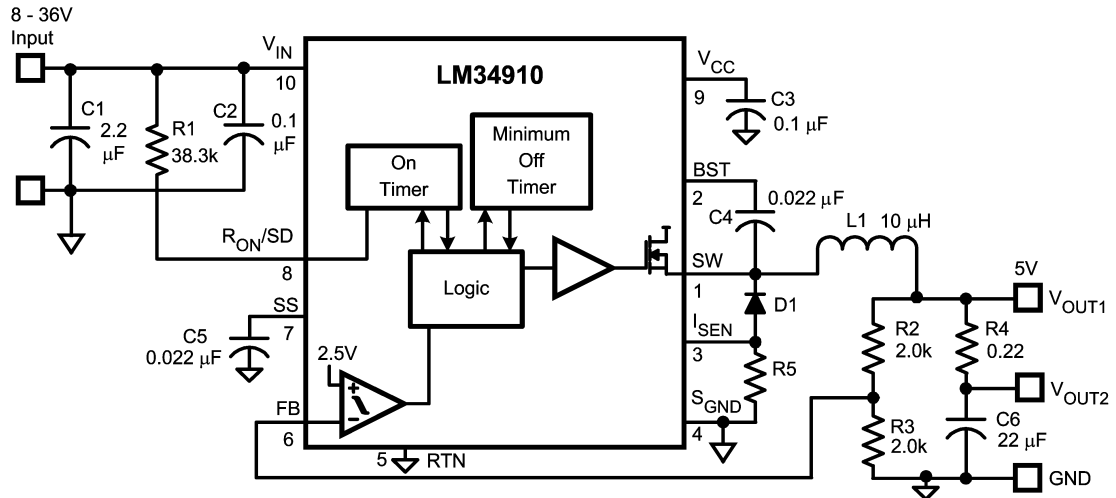

20131302

FIGURE 2. Board Schematic

## Bill of Materials

Item	Description	Mfg. Part No.	Package	Value
C1	Capacitor	TDK C3225X7R1H225K	1210	2.2 $\mu$ F, 50V
C2, 3	Capacitor	TDK C1608X7R1H104K	0603	0.1 $\mu$ F, 50V
C4, 5	Capacitor	TDK C1608X7R1H223K	0603	0.022 $\mu$ F, 16V
C6	Capacitor	TDK C3216Y5V1A226Z	1206	22 $\mu$ F, 10V
D1	Schottky diode	Zetex ZLLS2000	SOT-23-6	40V, 2.2A
L1	Inductor	TKD SLF6028T-100M1R3	6 mm x 6 mm	10 $\mu$ H, 1.3A
R1	Resistor	TDK CRCW06033832F100	0603	38.3 k $\Omega$
R2, 3	Resistor	TDK CRCW06032001F100	0603	2.0 k $\Omega$
R4	Resistor	Panasonic ERJ6RQFR22V	0805	0.22 $\Omega$ , 1/8W
R5	Resistor	See data sheet	0805	
U1	Switching Regulator	National Semi LM34910SD	LLP-10	

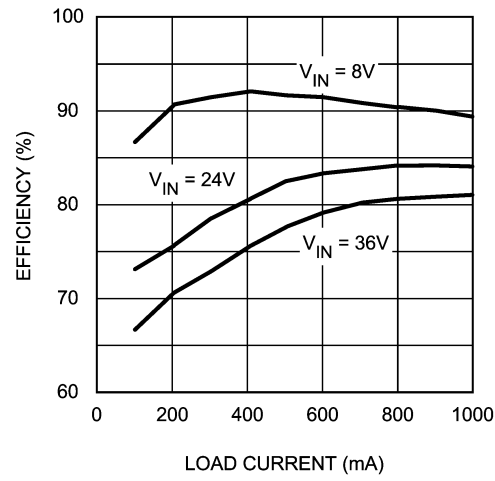

20131303

FIGURE 3. Efficiency vs Load Current

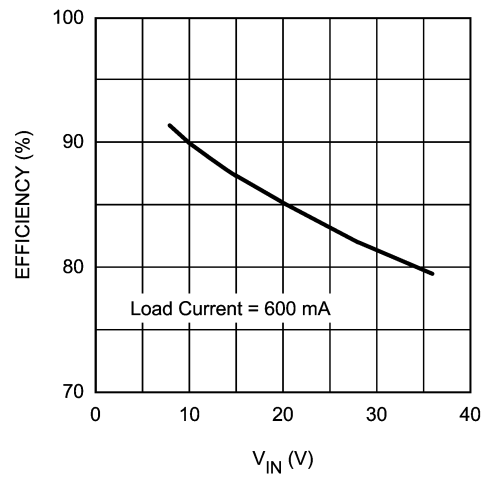

20131304

FIGURE 4. Efficiency vs  $V_{IN}$

# PCB Layout

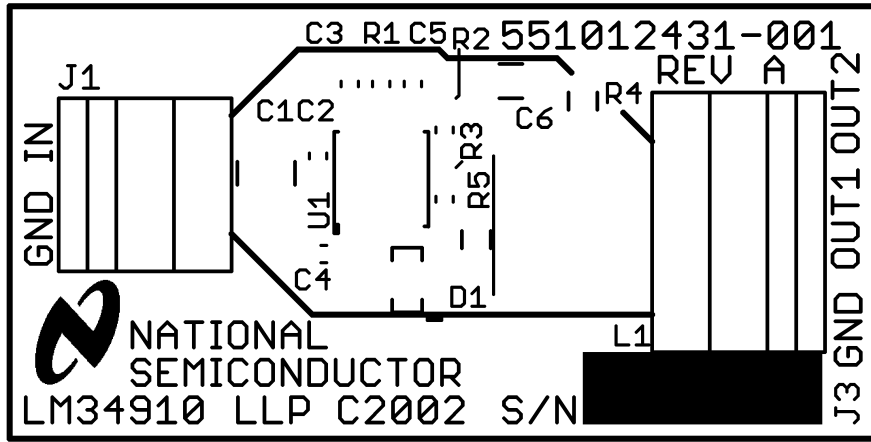

Board Silkscreen

20131305

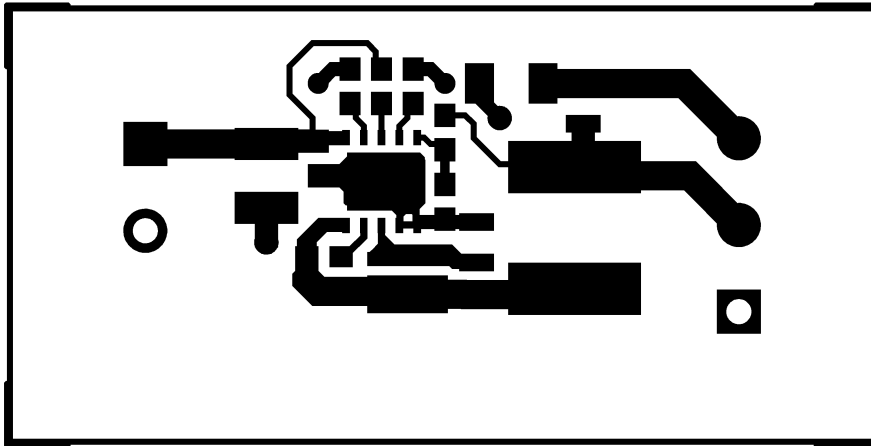

Board Top Layer

20131306

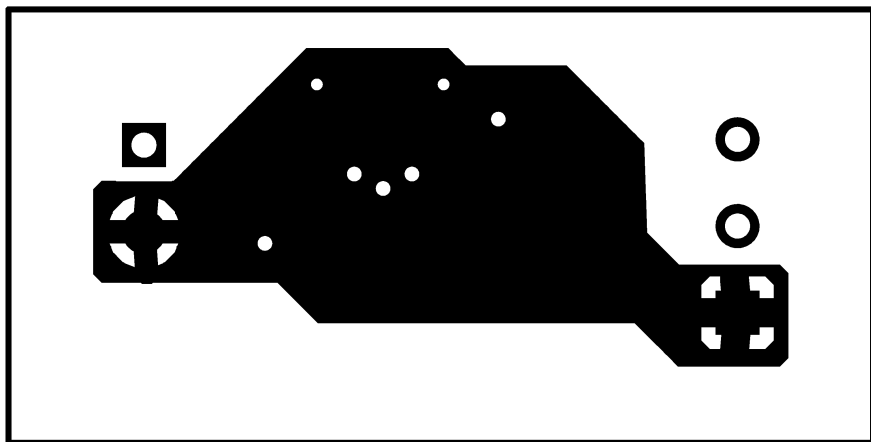

Board Bottom Layer

20131307

## Notes

National does not assume any responsibility for use of any circuitry described, no circuit patent licenses are implied and National reserves the right at any time without notice to change said circuitry and specifications.

For the most current product information visit us at [www.national.com](http://www.national.com).

### LIFE SUPPORT POLICY

NATIONAL'S PRODUCTS ARE NOT AUTHORIZED FOR USE AS CRITICAL COMPONENTS IN LIFE SUPPORT DEVICES OR SYSTEMS WITHOUT THE EXPRESS WRITTEN APPROVAL OF THE PRESIDENT AND GENERAL COUNSEL OF NATIONAL SEMICONDUCTOR CORPORATION. As used herein:

1. Life support devices or systems are devices or systems which, (a) are intended for surgical implant into the body, or (b) support or sustain life, and whose failure to perform when properly used in accordance with instructions for use provided in the labeling, can be reasonably expected to result in a significant injury to the user.
2. A critical component is any component of a life support device or system whose failure to perform can be reasonably expected to cause the failure of the life support device or system, or to affect its safety or effectiveness.

### BANNED SUBSTANCE COMPLIANCE

National Semiconductor certifies that the products and packing materials meet the provisions of the Customer Products Stewardship Specification (CSP-9-111C2) and the Banned Substances and Materials of Interest Specification (CSP-9-111S2) and contain no "Banned Substances" as defined in CSP-9-111S2.



**National Semiconductor**  
Americas Customer  
Support Center  
Email: [new.feedback@nsc.com](mailto:new.feedback@nsc.com)  
Tel: 1-800-272-9959

**National Semiconductor**  
Europe Customer Support Center  
Fax: +49 (0) 180-530 85 86  
Email: [europe.support@nsc.com](mailto:europe.support@nsc.com)  
Deutsch Tel: +49 (0) 69 9508 6208  
English Tel: +44 (0) 870 24 0 2171  
Français Tel: +33 (0) 1 41 91 8790

**National Semiconductor**  
Asia Pacific Customer  
Support Center  
Email: [ap.support@nsc.com](mailto:ap.support@nsc.com)

**National Semiconductor**  
Japan Customer Support Center  
Fax: 81-3-5639-7507  
Email: [jpn.feedback@nsc.com](mailto:jpn.feedback@nsc.com)  
Tel: 81-3-5639-7560

[www.national.com](http://www.national.com)